

Life Science

It's in your hands.



Excellence in Biorepository



BIOBANKING

- Conceptual Design
 - Engineering
 - IQ / OQ
 - ...
- ▶ p. 8



BIOSAFE® Working / Wide Neck Series

120 - 220 - 420 - 820
up to 51,200 vials, 2 ml
▶ p. 10



BIOSAFE® Longtime / Narrow Neck Series

500 - 800 - 1800 - 2400
up to 120,000 vials, 2 ml
▶ p. 17

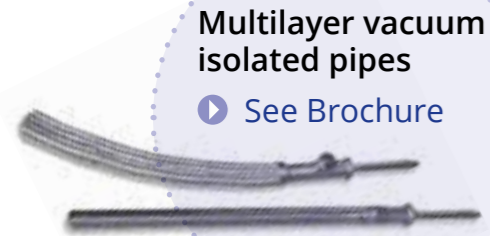

Multilayer vacuum isolated pipes

▶ See Brochure



APOLLO® Nitrogen Storage Vessel

50 - 350 l capacity
▶ S.38



ALPHA / JUNO® Nitrogen Storage & Transport Vessel

6 - 30 l capacity
▶ p. 36



BIOSAFE® MARATHON

Dry shipping vessel
up to 500 vials, 2 ml.
▶ p. 34



BIOSAFE® VENUS

For small to medium sample volumes up to 6,000 vials, 2 ml.
▶ p. 30



BIOSAFE® Rack-System

Standardised and individual design
▶ p. 22



BIOSAFE® smart

The digital brain of your biobank
▶ p. 9



BIOSAFE® iTrack

Intelligent sample management software
▶ p. 26

Cryopreservation using cryogenic liquefied nitrogen is an established and reliable practice in science, research, medicine, environmental research and engineering. The safe cooling down to -190°C in the gas phase as well as the inert atmosphere allow for optimal freezing and storage of valuable medical and biological samples and materials.

Cryotherm, a leading supplier of storage, transfer and transport systems, has been a renowned manufacturer of cryogenic technology products and services for almost 60 years.

BIOSAFE® systems by Cryotherm has long been synonymous with superior quality and safety. Experience, technology and our know-how make it easy for you to decide on BIOSAFE®. Advancing into the future with recent cutting-edge developments, we have expanded our BIOSAFE® line-up with new life science products.

Our BIOSAFE®-systems consist of:

- ▶ BIOSAFE® / VENUS cryogenic storage containers, made of stainless steel or aluminum for the storage of large, but also small sample quantities.
- ▶ BIOSAFE® smart, a level controller device and container monitoring system for reliable supply of cryogenic liquefied nitrogen
- ▶ BIOSAFE® VENUS – an aluminum container series for small to medium sample volumes.
- ▶ BIOSAFE® MARATHON – a dry shipping container for safe transport of your biological samples.
- ▶ BIOSAFE® GO is the practical and ergonomic workbench for the safe loading of your biological samples into vials, boxes, racks, etc.

BIOSAFE® - Systems An overview of our life science family.	2 - 3
Safety equipment Your safety is our priority.	6 - 7
Biobanking - BIOSAFE® smart The 'digital brain' of your biobank.	8 - 9
BIOSAFE® 120 - 220 - 420 - 820 The secure BIOSAFE® wide neck storage vessel series - for up to 51,200 cryogenic vials 2 ml	10 - 13
BIOSAFE® 500 - 800 - 1800 - 2400 The narrow neck BIOSAFE® Stainless Steel Series - for up to 120,000 cryogenic vials 2 ml	17 - 21
BIOSAFE® inventory systems Overview	22 - 23
BIOSAFE® iTrack Your intelligent sample management.	26 - 27
BIOSAFE® GO Ideal for handling your samples.	28
BIOSAFE® VENUS The safe storage for your samples - for up to 6,000 cryogenic vials 2 ml	30 - 33
BIOSAFE® MARATHON 25 MD For safe shipment of your samples - for up to 500 cryogenic vials 2 ml	34 - 35
ALPHA and JUNO® Unpressurized vessel series for transport with a capacity of 6 to 30 l	36 - 37
APOLLO® Vacuum super-insulated storage and transport vessel for liquid nitrogen with a capacity of 50 to 350 l	38 - 41



Body Protection



Cryo-Aprons	Beschreibung	Artikelnr.
length: approx. 920 mm, for protection from cryogenic fumes and splashes for temperature range to -160°C		77031519
length: approx. 1,380 mm, for protection from cryogenic fumes and splashes for temperature down to -160°C		77031520
Cryo-Protective Shield and Goggles		
Cryo-protective sign and inspection Glass 4	head protection signs of vulcanized fibre foam padded dimensions: (WxH) 460 x 190 mm	77031452
Safety goggles with side protection 3		0794189
Schild		
"Wear eye protection" 6	Adhesive Foil Ø 20 cm Symbol	78210204
"Wear hand protection" 7	Adhesive Foil Ø 20 cm Symbol	78210205



Cryo-Protective Equipment Full Set



Description	Item No.
Incl. Cryo-Gloves 1 , Cryo-Apron 4 , Cryo-Protective sign 5 and 2 warning Signs 6 + 7	78400851

Cryo-Gloves, waterproof



Description Hand protection, 5 fingers, down to -160° C	Length	Size	Item No.
Length: ca. 300 mm 1	Wrist	S	78400613
Length: ca. 300 mm	Wrist	M	78213086
Length: ca. 300 mm	Wrist	L	77031450
Length: ca. 300 mm	Wrist	XL	78400823
Length: ca. 400 mm 2	Forearm	S	78400843
Length: ca. 400 mm	Forearm	M	78400180
Length: ca. 400 mm	Forearm	L	78400887
Length: ca. 400 mm	Forearm	XL	78400856
Length: ca. 500 mm	Elbow	M	78400899
Length: ca. 500 mm	Elbow	L	77031451
Length: ca. 500 mm	Elbow	XL	78211327



The one-stop Biobank



60 YEARS Ice cold experience

Since almost 60 years we have been working closely with scientists and researchers.

On-site consultation

Our experts are looking forward to consult with you!

Excellence in Engineering

Your Turnkey Biobank: Everything in one full package!



Service / 24/7 hotline and maintenance

Always close to our customers.

4.0 Monitoring

Clever management of your entire biobank. Even from afar.

BIOSAFE® smart

The digital brain of your biobank.

Biobanking 4.0

100 % in control

Thanks to optional electromechanical locking, your samples are protected against access. Twofold access control via RFID transponder and PIN code. Logs all activities according to GMP FDA CRF 21 part 11.

Big Data

From monitoring to recording to evaluation of the sample cycle - Let data speak.

Touch Screen

Intuitive multifunctional 8.8" panel with colored touch display. Bright and functional.

Conversion Kit*

Your existing BIOSAFE® repository freezer can be updated with new BIOSAFE® smart. Item No. 78221956

* Cryotherm verifies feasibility.

Best durable

Protected by a sturdy glass panel, ideal for aseptic and medical environments.



Extensive special equipment

Various options for linking components such as warmgas bypass, UPS battery, lid lock, additional temperature sensors and much more.

Select your Software-Package

Config-Version

On-site BIOSAFE® monitoring via color display (included).

BIOSAFE® Info.View

On-site and remote monitoring of BIOSAFE® including secure data analysis and transfer, with the ability to connect up to 254 BIOSAFE® units in up to 10 cryobanks. optional: Item No. 78216677

BIOSAFE® Info.Alarm

contains all advantages of BIOSAFE® Info.View incl. messenger function via eMail. **System requirements:** Customer internet connection and email account. optional: Item No. 78216678

BIOSAFE® 120 - 220 - 420 - 820

Our secure BIOSAFE® Wide Neck Storage Vessel Series.

All Advantages at a Glance



Storing samples for

science | research | human genetics | pharmacology | hygienics & environmental medicine | bio-chemistry | laboratory medicine | transfusion medicine | reproduction medicine (IVF) | oncology | micro- and macrobiology | pathology | forensic medicine | virology | tropical medicine | veterinary genetics | plants genetics | science | research | pharmacology | hygienics & environmental medicine | bio-chemistry | laboratory medicine | transfusion medicine (IVF) | micro- and macrobiology | pathology | forensic medicine | research | human genetics | bio-chemistry | laboratory medicine | transfusion medicine (IVF) | micro- and macrobiology | pathology | forensic medicine | research | human genetics | bio-chemistry | laboratory medicine | transfusion medicine | reproduction medicine (IVF) | oncology | micro- and macrobiology | pathology | virology | forensic medicine | bio-chemistry | laboratory medicine | transfusion medicine | reproduction medicine

Our BIOSAFE® systems 120 to 820 are optimised for maximum capacity with minimised external dimensions. The large, thermodynamically optimised, vacuum-insulated lid that comes with an attractive design makes it possible to access stored materials in just seconds.

Filling of samples takes place through the wide neck opening in the freely accessible storage compartment. The solid construction, made of polished, stainless steel, ensures maximum life time and a low evaporation rate. A combined vacuum closure and safety device for the vacuum chamber provides additional security.



BIOSAFE® 120 - 220 - 420 - 820

The practical working biorepository system.



All Advantages at a Glance



Distinctive & sophisticated:
Ergonomic lifting and swivelling mechanism / Low, user-friendly vessel height.

Ahead of the market:
Our integrated BIOSAFE® smart control
for level control and vessel monitoring.

Double the safety!
Mechanically and (optional) electronically lockable lid.

TOP accessibility
to your samples, ideal for frequent usage.

Well-thought-out:
Depending on the vessel size, high nitrogen reserves below the shelf floor will last several days.

Optimised storage capacity
by utilising space-saving smart rack systems.

High storage capacity
for up to 51,200 samples, 2 ml vials.

Low evaporation rates

Smooth surfaces, that are **easy to disinfect** - even on top of the lid.



BIOSAFE® 120 - 220 - 420 - 820

Visual Insights.

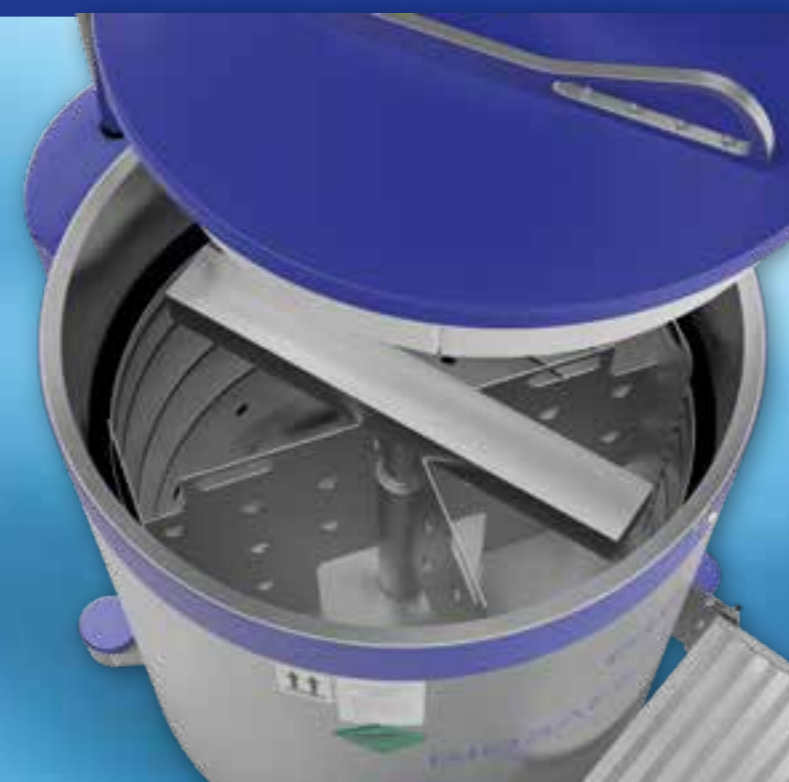

BIOSAFE® 120 - 220 - 420 - 820

Ideal for routine work with biological-medical samples.



Technical Data



Wide-neck BIOSAFE®		120	220	420	820
Neck/ inside diameter	A [mm]	514	664	854	1,091
LIN Capacity under platform	[l]	21	35	57	140
Weight, empty	[kg]	100	175	225	600
Diameter, outside	B [mm]	560	710	900	1,150
Total height	C [mm]	1,420*	1,680	1,680	2,222
Operating height**	D [mm]	1,050	1,070	1,070	970
Installation altitude for racks	[mm]	625	625	625	915
Caster diameter	[mm]	-	80	80	63
Evaporation rate	[%/day]	2.3	2.0	1.5	1,2

*) without rollerbase

***) BIOSAFE® 820 measured from step, BIOSAFE® 120 / 220 / 420 from bottom

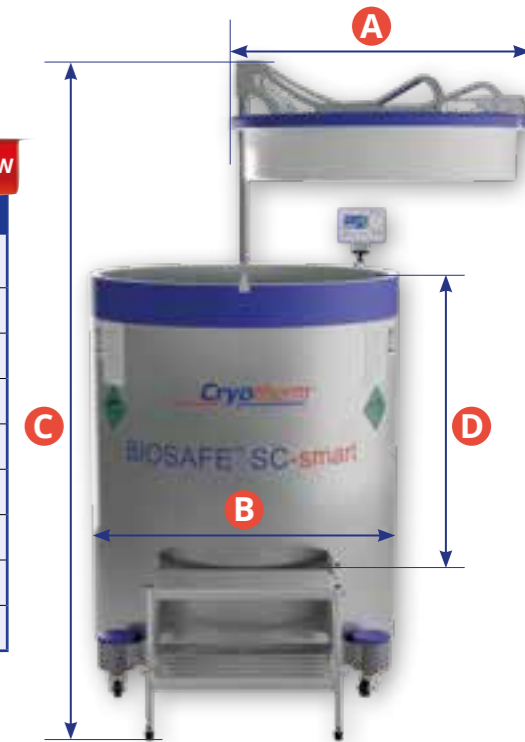

Storage Capacities



Wide-neck BIOSAFE®		120	220	420	820
Geometric content	[l]	151	251	420	888
2 ml vials	[max./up to]	7,000	13,000	23,100*	51,200

*) for 2 ml vials in Cryotherm drawer system



BIOSAFE® 120

Storage capacity: up to 7,000 vials



- **7 smart racks à 570 x 140 x 136 mm, 10 levels,**
Item No.: 78221976 for smart rack per pc.
- suitable for cryoboxes, 10 x 10 pieces,
Dimension: 53 x 132 x 132 mm
Item No.: 78212859
- or cryoboxes, 9 x 9 pieces
Dimension: 53 x 132 x 132 mm
Item No.: 78214364

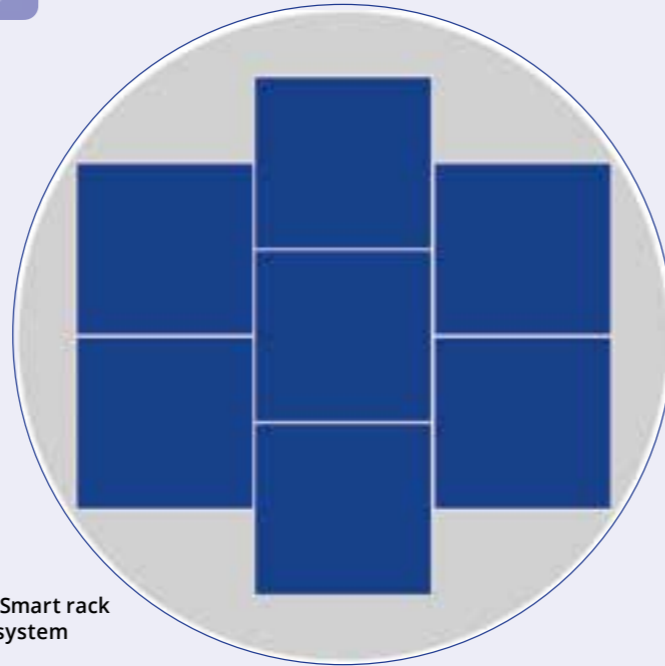

Smart rack including cryobox



Smart rack system

BIOSAFE® 420

Storage capacity: up to 22,000 vials

BIOSAFE® 420

Storage capacity: up to 22,000 vials



- **20 smart racks à 570 x 140 x 136 mm, 10 levels**
Item No.: 78221976 for smart rack per pc.
- suitable for cryoboxes, 10 x 10 pieces
Dimension: 53 x 132 x 132 mm
Item No.: 78212859
- or cryoboxes, 9 x 9 pieces
Dimension: 53 x 132 x 132 mm
Item No.: 78214364
- **8 Smart-Racks à 570 x 84 x 78 mm, 10 Etagen**
Item No.: 78222196 for smart rack per pc.
- suitable for cryoboxes, 5 x 5 pieces
Dimension: 52 x 75 x 75 mm
Item No.: 78202839

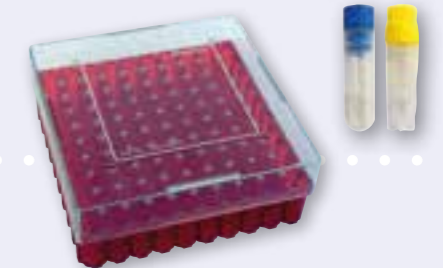
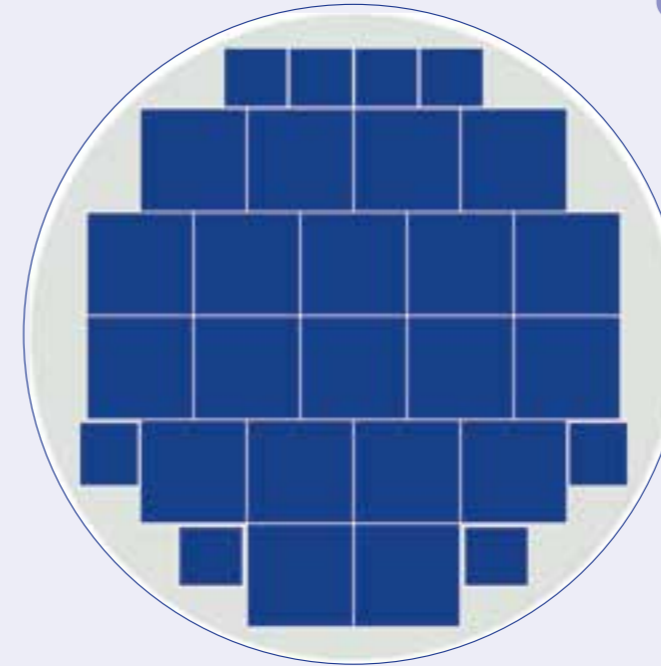

BIOSAFE® 220

Storage capacity: up to 13,000 vials



- **12 smart racks à 570 x 140 x 136 mm, 10 levels,**
Item No.: 78221976 for smart rack per pc.
- suitable for cryoboxes, 10 x 10 pieces
Dimension: 53 x 132 x 132 mm
Item No.: 78212859
- or cryoboxes, 9 x 9 pieces
Dimension: 53 x 132 x 132 mm
Item No.: 78214364
- **4 smart racks à 570 x 84 x 78 mm, 10 levels,**
Item No.: 78222196 for smart rack per pc.
- suitable for cryoboxes, 5 x 5 pieces
Dimension: 52 x 75 x 75 mm
Item No.: 78212860

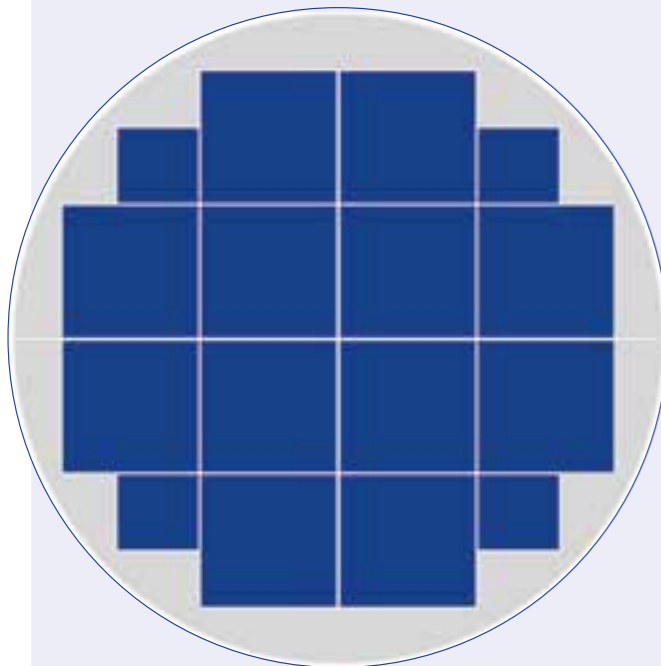

BIOSAFE® 820 NEW

Storage capacity: up to 51,200 vials



- **32 Smart-Racks à 915 x 140 x 136 mm, 16 Etagen**
Item No.: 78221742
- suitable for cryoboxes, 10 x 10 pieces
Dimension: 53 x 132 x 132 mm
Item No.: 78212859
- or cryoboxes, 9 x 9 pieces
Dimension: 53 x 132 x 132 mm
Item No.: 78214364

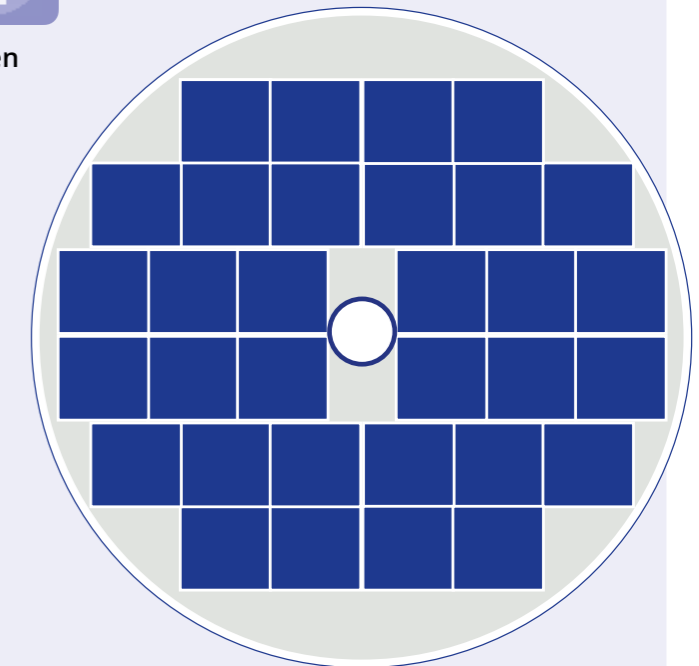
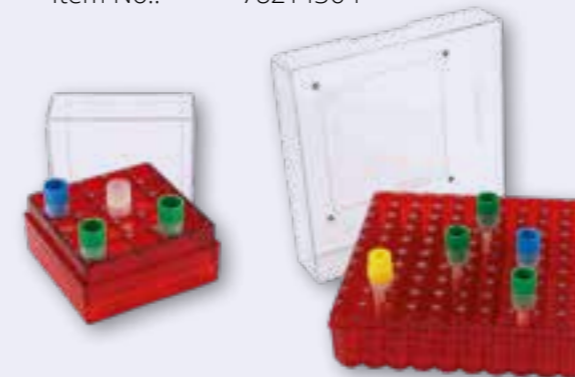

Our Narrow Neck BIOSAFE® Series.



© Photo:



All Advantages at a Glance



Storing samples for

science | research | human genetics | pharmacology | hygiene | dental medicine |
 bio-chemistry | neuroscience | transfusion medicine | production
 medicine | microbiology | forensic science |
 medicine | veterinary genetics | science |
 research | pathology | hygiene | medicine |
 bio-chemistry | transfusion medicine | medicine |
 (IVF) | pathology | forensic medicine |
 virology | primary genetics | plants genetics | science |
 research | pathology |
 bio-chemistry | transfusion
 (IVF) | pathology |
 virology | primary ge
 research | pathology |
 bio-chemistry | transfusion
 oncology | microbiology | pathology |
 ne | virology | medicine | veterinary
 | research | human genetics | pharmacology |
 bio-chemistry | laboratory medicine | transfusion medicine | reproduction
 forensic



picture of the BIOSAFE® 800



Cryogenic facilities with > 100 freezers
 © Photo Fraunhofer IBMT, Dr. Obergrießer

Our BIOSAFE® systems 500 to 2400 are optimised for maximum capacity with minimum consumption. In the range of 500 litres to 2400 litres and more, the containers can be easily loaded via the side-mounted vessel neck and the smooth-running carousel. Smooth-running castors ensure the mobility of our BIOSAFE® storage vessels and provide even more flexibility.

BIOSAFE® 500 - 800 - 1800 - 2400

The safe bank. The long-term storage BIOSAFE® series.

All Advantages at a Glance



Zero-gravity lid technology

A convenient spring supported lid lets you open BIOSAFE® with one hand and zero effort.

Engineered for Excellence

Made in Germany to the highest standards for medical devices (MDD 93/42 EEC), BIOSAFE® features design and materials that are optimised for aseptic environments.

Double the safety!

Mechanically and (optional) electronically lockable lid.

Ahead of the market: Integrated BIOSAFE® smart-control

provides level control and vessel monitoring

Best in its class!

Store up to 120,000 2 ml samples in just one BIOSAFE® vessel. Unbeatable amount!

TOP-Handling

Smooth carousel for quick and safe usage.

Sophisticated ergonomics

Convenient steps, handles and a user-friendly low operating height ensure safe and comfortable handling.

More than just safe

Numerous options for redundant vessel monitoring for GMP-compliant applications.



BIOSAFE® 500 - 800 - 1800 - 2400

Our Narrow Neck BIOSAFE® Stainless Steel Series.



Technical Data



Longtime storage BIOSAFE®	500	800	1800	2400
Neck diameter A [mm]	450	520	830	830
LIN Capacity under platform [l]	50	116	287	320
Weight, empty [kg]	320	560	1,100	1,300
Diameter, outside B [mm]	890	1,058	1,500	1,650
Diameter, inside / carousel [mm]	795	966	1,346	1,500
Total height C [mm]	1,340	1,380	2,150	2,150
Operating height D [mm]	1,014	1,080	1,070	1,070
Installation altitude for racks [mm]	800	800	915	915
Caster diameter [mm]	80	80	100	100
Evaporation rate [%/day]	1.2	1.0	0.7	0.6

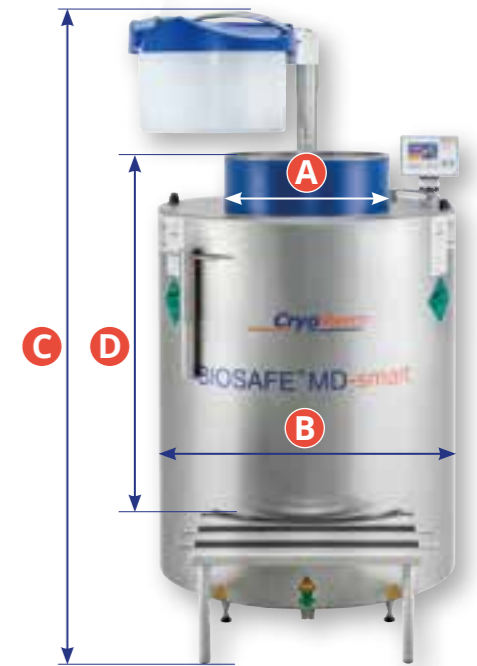

Storage Capacities



Longtime storage BIOSAFE®	500	800	1800	2400
Geometric content [l]	490	960	1,800	2,400
2 ml vials [max./up to]	28,280	43,120	92,800	120,000

Automation in the Cryobank



Picture of a BIOSAFE® 8800, with a capacity of 1 mil. vials 2 ml for individual cryobanking project.

BIOSAFE® 500

Storage capacity: up to 28,280 vials



- **18 smart racks à 800 x 140 x 136 mm, 14 levels**
Item No. 78221978 for smart rack per pc.
- suitable for cryoboxes 10 x 10 pieces
dimensions: 53 x 132 x 132 mm
Item No. 78212859
- or cryoboxes 9 x 9 pieces
dimensions: 53 x 132 x 132 mm
Item No. 78214364
- **2 smart racks à 800 x 84 x 78 mm, 14 levels**
Item No. 78222198 for smart rack per pc.
- suitable for cryoboxes 5 x 5 pieces
dimensions: 52 x 75 x 75 mm

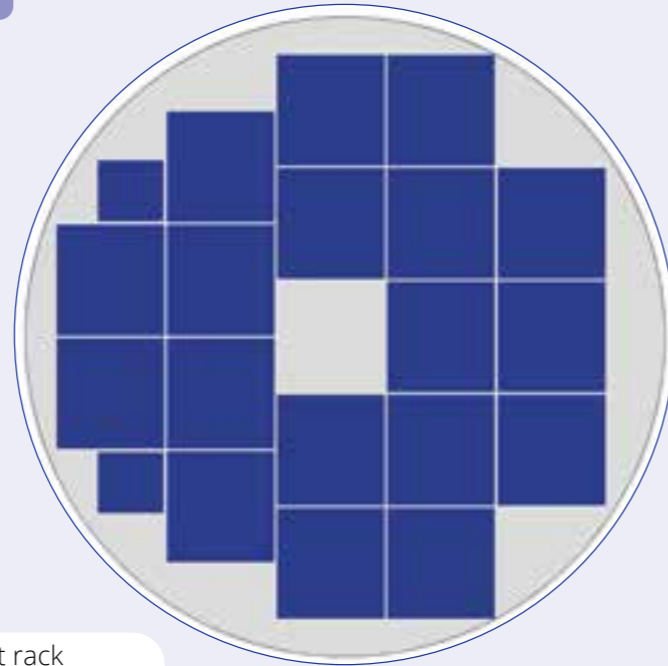

BIOSAFE® 1800

Storage capacity: up to 92,800 vials



- **52 smart racks à 915 x 140 x 136 mm, 16 levels**
Item No. 78221742 for smart rack per pc.
- suitable for cryoboxes 10 x 10 pieces
dimensions: 53 x 132 x 132 mm
Item No. 78212859
- or cryoboxes 9 x 9 pieces
dimensions: 53 x 132 x 132 mm
Item No. 78214364
- **24 smart racks à 915 x 84 x 78 mm, 16 levels**
Item No. 78222199 for smart rack per pc.
- suitable for cryoboxes 5 x 5 pieces
dimensions: 52 x 75 x 75 mm

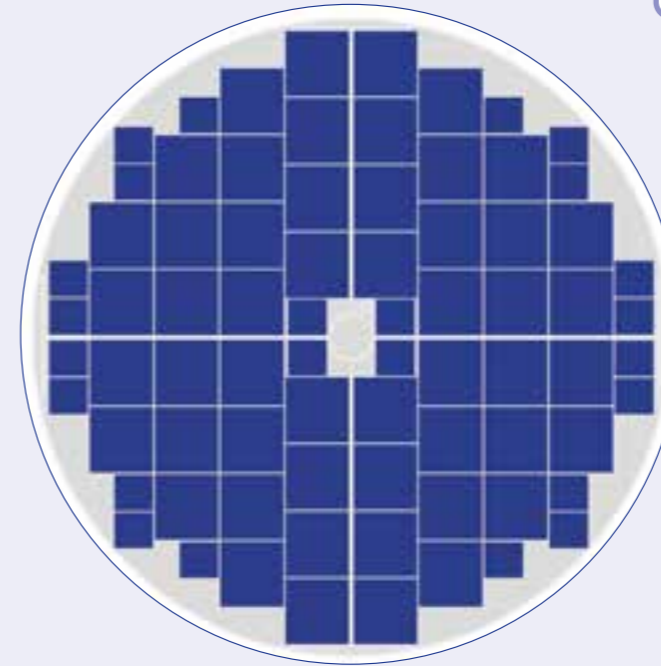

Smart rack system

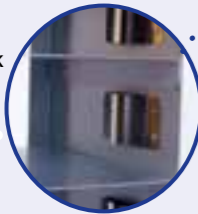

Smart rack including cryobox

BIOSAFE® 800

Storage capacity: up to 40,600 vials



- **26 smart racks à 800 x 140 x 136 mm, 14 levels**
Item No. 78221978 for smart rack per pc.
- suitable for cryoboxes 10 x 10 pieces
dimensions: 53 x 132 x 132 mm
Item No. 78212859
- or cryoboxes 9 x 9 pieces
dimensions: 53 x 132 x 132 mm
Item No. 78214364
- **12 smart racks à 800 x 84 x 78 mm, 14 levels**
Item No. 78222198 for smart rack per pc.
- suitable for cryoboxes 5 x 5 pieces
dimensions: 52 x 75 x 75 mm

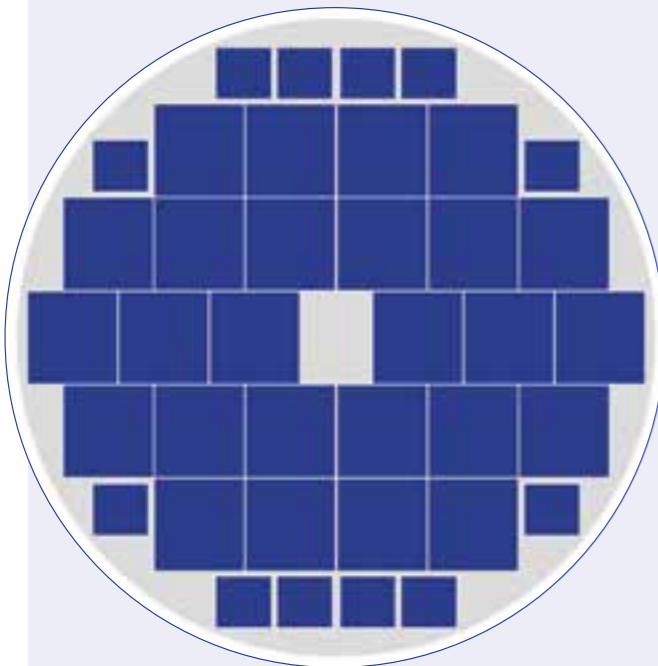

BIOSAFE® 2400

Storage capacity: up to 120,000 vials



- **68 smart racks à 915 x 140 x 136 mm, 16 levels**
Item No. 78221742 for smart rack per pc.
- suitable for cryoboxes 10 x 10 pieces
dimensions: 53 x 132 x 132 mm
Item No. 78212859
- or cryoboxes 9 x 9 pieces
dimensions: 53 x 132 x 132 mm
Item No. 78214364
- **28 smart racks à 915 x 84 x 78 mm, 16 levels**
Item No. 78222199 for smart rack per pc.
- suitable for cryoboxes 5 x 5 pieces
dimensions: 52 x 75 x 75 mm
Item No. 78212860

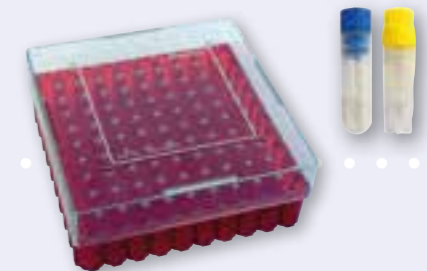
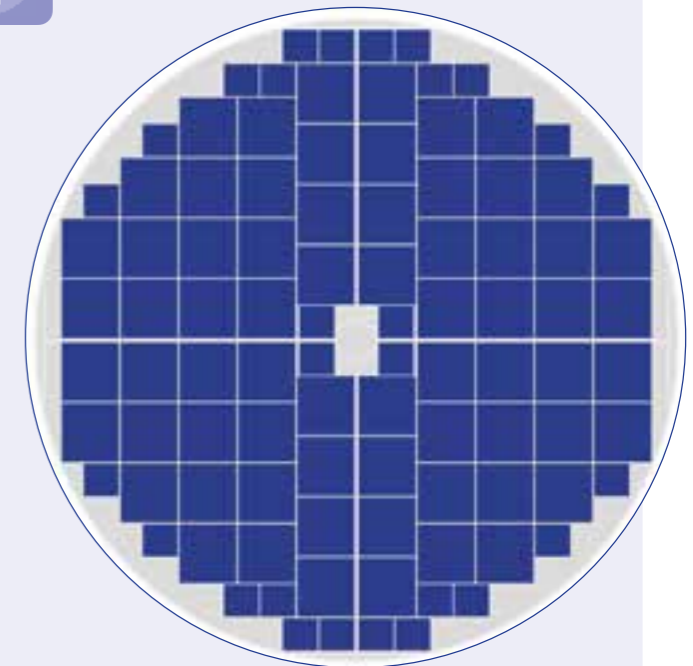

Your needed Packaging



Our various Solutions



For your BIOSAFE® Repository Freezers



GAS PHASE: liquid under the platform; samples immersed in N₂ vapours (temperatures around -180°C)

LIQUID PHASE: Samples completely immersed in liquid nitrogen (temperatures around -190°C)

Possibility of both types of cryopreservation through probe length adaptation



All Advantages at a Glance

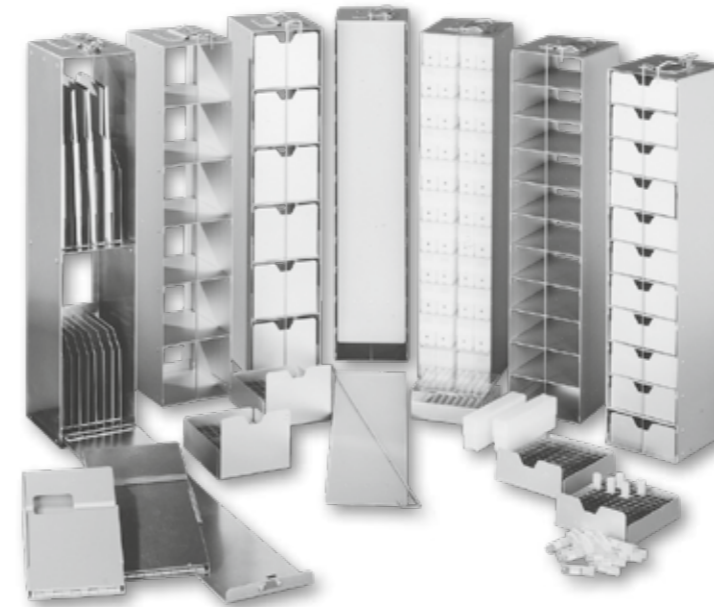

New Smart racks

- ▶ High storage capacity with new High Efficiency system
- ▶ Safety fixation system
- ▶ Maximum protection for your samples
- ▶ Various heights for flexible use and compatibility with all biorepository freezers
- ▶ Variable arrangements for setting your own order system
- ▶ Low tare weight due to sturdy aluminium construction
- ▶ Transparency by means of sample management system



For more information
BIOSAFE® iTrack page 25

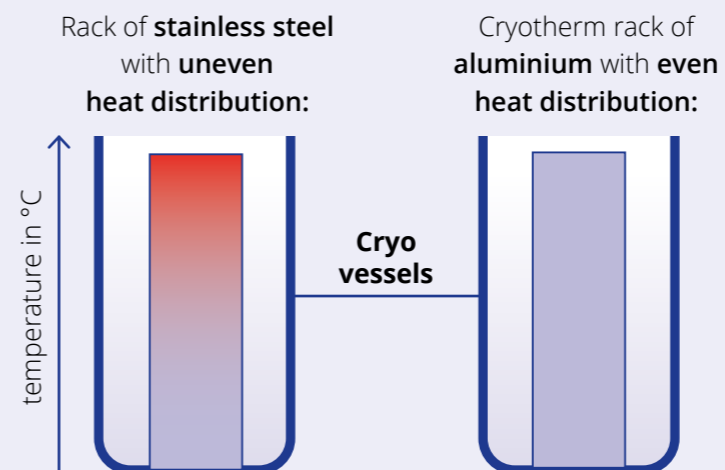

For detailed information please regard dedicated brochure for inventory systems.



Functional Favorite



BIOSAFE® smart is an on-site vessel monitoring system with the following abilities:

- Level control and monitoring, automatic filling and temperature logging
- Monitoring and evaluation of alarms and events
- Data analysis and transfer according to GMP / FDA CRF 21 Part 11
- Access restriction to control functions on administration level via PIN or RFID transponder
- Visual and audible alarm on the touch-display, with existing internet connection with BIOSAFE® View Info Software also as e-mail
- Forwarding of alarms (potential-free contacts) and temperature (4-20mA signal)
- Possibility to connect a redundant level measurement for alarming purposes (optional for BIOSAFE® narrow neck lines)
- Mechanical and electrical lid locking (optional for BIOSAFE® narrow neck lines)
- Temperature monitoring with up to three temperature sensors
- Other optional equipment: Warmgas bypass, UPS backup battery

Other clear BIOSAFE® smart plus points are:

- Audit trail on control actions and settings
- Networking via TCP/IP or Modbus (option) of up to 256 devices via their own physical, static subnet and a remote desktop connection.
- Extension to comprehensive cryobank management via BIOSAFE® smart BSIO Box (option)
- Linking options with existing systems via several digital and potential-free inputs and outputs, as well as analog connections
- PLC function with five freely programmable channels for extensive adaptation to individual Adaptation to individual customer requirements thanks to BIOSAFE® View Software

Main accessories

BIOSAFE® 120 - 2400

<input checked="" type="checkbox"/> Item No.	Short text	Pcs
<input type="checkbox"/> 78202845	Rollerbase for BIOSAFE® 120	_____
<input type="checkbox"/> 78202830	Transport aid for BIOSAFE® 220 - 800	_____
<input type="checkbox"/> 78224556	Temp. booster gas phase storage BIOSAFE® 120	_____
<input type="checkbox"/> 78224557	Temp. booster gas phase storage BIOSAFE® 220	_____
<input type="checkbox"/> 78224115	Temp. booster gas phase storage BIOSAFE® 420	_____
<input type="checkbox"/> 78216677	BIOSAFE®-view Info	_____
<input type="checkbox"/> 78216678	BIOSAFE®-view InfoAlarm	_____
<input type="checkbox"/> 78217372	MODBUS for BIOSAFE® smart	_____
<input type="checkbox"/> 78216670	Network switch 8x	_____
<input type="checkbox"/> 78222466	Second solenoid valve	_____
<input type="checkbox"/> 78222354	Warmgas bypass BIOSAFE® smart 120 - 800	_____
<input type="checkbox"/> 78222355	Warmgas bypass with add. Main-valve, BIOSAFE® smart 120 - 800	_____
<input type="checkbox"/> 78221877	Warmgas bypass BIOSAFE® smart 1800 - 2400	_____

Your BIOSAFE® Biorepository Freezer

BIOSAFE® 120 - 2400		230 V	certified CE MDD 93/42 EEC according to class IIa
<input checked="" type="checkbox"/> Item No.	<input checked="" type="checkbox"/> Item No.	Short text	Pcs
<input type="checkbox"/> 78221903	<input type="checkbox"/> 78221879	BIOSAFE® 120 smart	_____
<input type="checkbox"/> 78221906	<input type="checkbox"/> 78221882	BIOSAFE® 220 smart	_____
<input type="checkbox"/> 78221909	<input type="checkbox"/> 78221885	BIOSAFE® 420 smart	_____
<input type="checkbox"/> 78221912	<input type="checkbox"/> 78221888	BIOSAFE® 500 smart	_____
<input type="checkbox"/> 78223148	<input type="checkbox"/> 78223145	BIOSAFE® 800 smart	_____
<input type="checkbox"/> 78224877	<input type="checkbox"/> n/a	BIOSAFE® 820 smart	_____
<input type="checkbox"/> 78223480	<input type="checkbox"/> n/a	BIOSAFE® 1800 smart	_____
<input type="checkbox"/> 78221924	<input type="checkbox"/> 78221600	BIOSAFE® 2400 smart	_____
<input type="checkbox"/> 78221956		Conversion kit for existing BIOSAFE® repository freezer	_____
<input type="checkbox"/> 78217486		BIOSAFE®-smart I/O-Box incl. cabinet	_____
<input type="checkbox"/> 78222361		Temperatur sensor for BIOSAFE® smart (additional)	_____
<input type="checkbox"/> 78222353		Battery backup 24VDC for BIOSAFE® smart	_____



Tracking your Cryogenic Samples



Example of 2D Scanner

Not included in delivery.



BIOSAFE® iTrack is a central database that can manage your stored samples based on their storage position. It can easily be adapted to the individual needs of your biobank. The necessary basic information and additional user defined information is linked to each sample. This information may be different data templates, logistics information or process data.

All Advantages at a Glance



- User friendly storage management
- FDA 21 CFR Part 11 compliance
- Sample based temperature logging
- Highest degree of data encryption for your sensitive data
- Developed, tested and documented according to ISO 13485, ISO 62304, IEC 62366
- User-defined storage structures/layouts
- Comprehensive storage level access rights
- Barcode scanner and RFID support
- User-defined sample data templates
- Visualisation of storage locations and containers
- Single/Multiple sample check in/out
- Single/Multiple sample data modification
- Comprehensive reporting PDF
- Comprehensive data Exports PDF/CSV
- Multiple IDs possible
- Windows based system
- Multi-site/multi database support
- 2D Flatbed scanner support
- Lab OS Web Access /Customer requests
- Electronic signatures ("A face four eyes check" feature)



Item Numbers



With BIOSAFE® iTrack we offer you various options for software support, whether for vials, bags, straws or individual packaging for your samples,

BIOSAFE® iTrack

<input checked="" type="checkbox"/> Item no.	
<input type="checkbox"/> 78217135	BIOSAFE® iTrack 3 years - Software support for a term of three years, for up to 5 users, one computer installation (on one laptop or PC)
<input type="checkbox"/> 78217140	BIOSAFE® iTrack 3 years - Extra CAL license for one additional computer installation
<input type="checkbox"/> 78217142	BIOSAFE® iTrack 3 years - Extension for each additional user
<input type="checkbox"/> 78217137	BIOSAFE® iTrack 3 years - Webaccess* for the secure mobile access to sample database with search and read permission (search, request & order samples)
<input type="checkbox"/> 78217136	BIOSAFE® iTrack 5 years - Software support for a term of three years, for up to 5 users, one computer installation (on one PC, laptop)
<input type="checkbox"/> 78216916	BIOSAFE® iTrack 5 years - Extra CAL license for one additional computer installation
<input type="checkbox"/> 78216917	BIOSAFE® iTrack 5 years - Extension for each additional user
<input type="checkbox"/> 78217138	BIOSAFE® iTrack 5 years - Webaccess* for the secure mobile access to sample database with search and read permission (search, request & order samples)
<input type="checkbox"/> 78217143	BIOSAFE® iTrack Remote-Training**

*) Access depending on administrative authorization . **) Remote maintenance by telephone or remote access are limited to a maximum, monthly hourly quota of three hours within the corresponding contract period.

Ideal for safe handling of your samples.

All Advantages at a Glance



BIOSAFE® GO is the practical and ergonomic workbench for the safe further processing of your biological samples in vials, boxes, racks, etc. Optimal for the the transport of large sample volumes from one container to another other container in a cryobank, e.g. relocation.



- ▶ Sample handling and transport of two horizontal towers in cryogenic N2 gas phase
- ▶ Vacuum insulated storage container mounted on a stainless steel transport cart
- ▶ Additional opening with plug for level measurement
- ▶ Temperature booster made of aluminum for low temperatures in the working chamber
- ▶ LN2 filling device with ball valve and 1.5 m insulated filling hose connection
- ▶ Two accesses for T-probes and mounting options for temperature logger
- ▶ Movable sample handling table
- ▶ Two separately opening lid halves

Datalogger
for temperature recordings,
with GPS on request. Item No. 78224306



exemplary
illustration

Technical Data



BIOSAFE® GO		
Geometrical capacity	[l]	150
LN2 capacity	[l]	30
Total length x width x height	[mm]	1,450 x 620 x 970
Inner length x width x height	[mm]	1,030 x 445 x 450
Opening, access (length x width)	[mm]	1,030 x 445
Operating height	[mm]	920
Storage height	[mm]	275
Filling height	[mm]	110
Weight empty	[kg]	115
Weight full (N2)	[kg]	173
Evaporation rate	[%/day]	2,5
Castor diameter	[mm]	125
With 2 lids, ball valve 3/8", safety relief valve 5 bar, insulated decanting hose length 1.5m and transport stopper DN50		 Item No. 78223611



© Photo: CREAPHARM BIOSERVICES



All Advantages at a Glance



The safe aluminum storage vessel.
Ideal for biological-medical samples.

- ▶ For up to 6,000 samples 2 ml vials in gas or liquid phase
- ▶ For straws in up to 96 goblets à 65 mm
- ▶ For up to 108 bags 250 / 500 ml

Table for dimensions

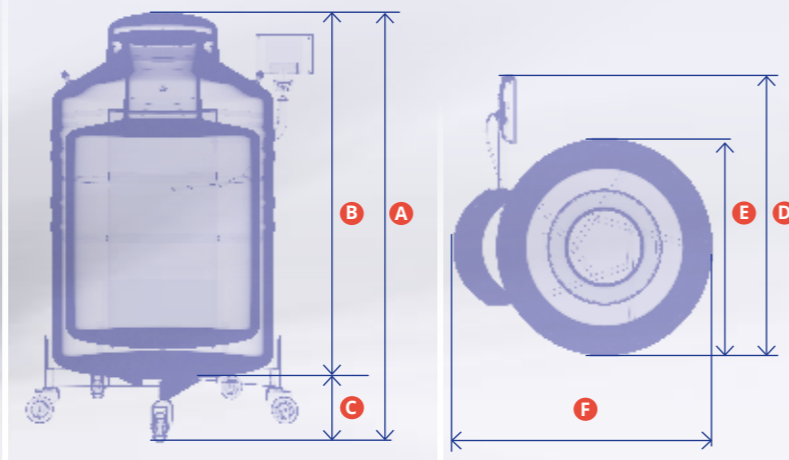

Technical Data



BIOSAFE® VENUS		150	180
Neck diameter	[mm]	216	216
Weight, empty (as delivered, with rack system and BIOSAFE® smart electronics)	[kg]	96	105
Weight, full (in real operation with LIN, max.)	[kg]	192	245
Total height	[mm]	A 1,100	1,215
Height of vessel	[mm]	B 950	1,065
Height of roller base	[mm]	C 140	140
Diameter, outside	[mm]	E 678	678
Depth max.	[mm]	F 840	840
Width max.	[mm]	D 820	820
Daily evaporation	[%/day]*	0.79	0.54
Static holding time	[days]*	148	181
Static holding time	[days]*	13	13

*The daily evaporation rate and the static holding time were determined at 20 degrees Celsius, 1013 hectopascal, with the vessel standing still, lid closed and without accessories. These are nominal values that may change depending on the use and age of the container.



Folding lid
Item No. 78217562

Insulation plug
Item No. 78217561



Smart-rack system for a comfortable and safe access to your samples

Individual numbering for clear placement

Storage Capacities



BIOSAFE® VENUS		150	180
Liquid phase / Gas phase			
Nominal volume	[l]	120	175
Racks (aluminum)	[piece]	6	6
Number of levels usable	[quantity]	8	7/8
2 ml cryogenic vials in 10x10 boxes	[up to]	4,800	4,200
Size of cryogenic boxes 10x10 (hxwxd)	[mm]	132 x 132 x 53	132 x 132 x 53
Daisy goblets	[up to]	72	48
Bags 250/500 ml (77031488)	[up to]	54	108

Further vessel sizes and accessories upon request.

Dedicated inventory system & accessories for the VENUS

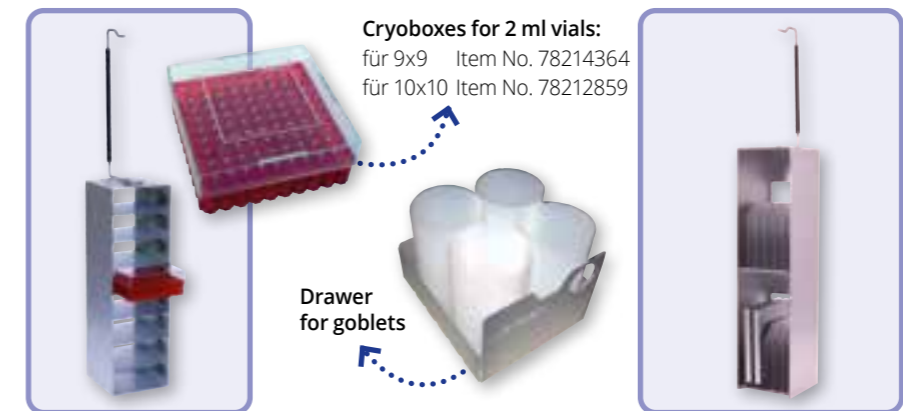

Smart rack for vials

VENUS 150 Item No. 78217554
VENUS 180 Item No. 78217555

Rack for goblets

VENUS 150 Item No. 78217556
VENUS 180 Item No. 78217557

Smart rack for bags

VENUS 150 Item No. 78217558
VENUS 180 Item No. 78217559



Cryo-Gloves

Length: ca. 400 mm
Item No.
Size S: 78400843
Size M: 78400180
Size L: 78400887
Size XL: 78400856



Cryo-protective sign

Item No. 77031452

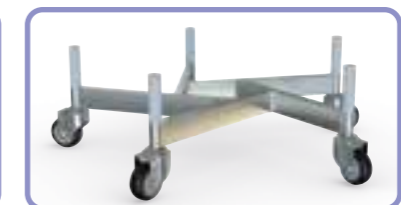

Roller base

Ø 687 mm (interior), height 140 mm with five swivel castors, three of them lockable: Item No. 78217560



Multicolor goblets with lid and divider for an easy identification



Gas phase storage

Your samples are stored in the gas phase, without contact to liquid nitrogen. The usable levels secure the storage in gas phase.



Liquid phase storage

Your samples are stored up to 100% in the liquid phase at temperatures down to -196°C.

BIOSAFE® VENUS

equipped with BIOSAFE® smart.



Functional Favorite



BIOSAFE® smart is an on-site vessel monitoring system with the following abilities:

- Level control and monitoring, automatic filling and temperature logging
- Monitoring and evaluation of alarms and events
- Data analysis and transfer according to GMP / FDA CRF 21 Part 11
- Access restriction to control functions on administration level via PIN or RFID transponder
- Visual and audible alarm on the touch-display, with existing internet connection with BIOSAFE® View Info Software also as e-mail
- Forwarding of alarms (potential-free contacts) and temperature (4-20mA signal)
- Possibility to connect a redundant level measurement for alarming purposes (optional for BIOSAFE® narrow neck lines)
- Mechanical and electrical lid locking (optional for BIOSAFE® narrow neck lines)
- Temperature monitoring with up to three temperature sensors
- Other optional equipment: Warmgas bypass, UPS backup battery

Other clear BIOSAFE® smart plus points are:

- Audit trail on control actions and settings
- Networking via TCP/IP or Modbus (option) of up to 256 devices via their own physical, static subnet and a remote desktop connection.
- Extension to comprehensive cryobank management via BIOSAFE® smart BSIO Box (option)
- Linking options with existing systems via several digital and potential-free inputs and outputs, as well as analog connections
- PLC function with five freely programmable channels for extensive adaptation to individual Adaptation to individual customer requirements thanks to BIOSAFE® View Software

All from one source



BIOSAFE® VENUS

With the BIOSAFE® smart for the Venus series, an automatic refill system can be connected conveniently, easily and safely. For the nitrogen supply, the APOLLO® series is available.



Further information concerning APOLLO® series from page 38.

BIOSAFE® VENUS

Order form.

Item Numbers



Our BIOSAFE® VENUS vessels are available in capacities from 150 to nearly 180 litres.

For your BIOSAFE® VENUS we supply various equipment options and extensive accessories.

BIOSAFE® VENUS Vessel Options

<input checked="" type="checkbox"/> Item No.		Quantity
<input type="checkbox"/> 78224110	BIOSAFE® VENUS 150 SC, incl. roller base and connecting hose 1.5 m to APOLLO®, for up to 6 racks, max 8 levels*	
<input type="checkbox"/> 78217554	BIOSAFE® VENUS 150 smart rack for vials 2ml**, 8 levels (single item number)	
<input type="checkbox"/> 78217556	BIOSAFE® VENUS 150 smart rack for goblets with drawers*** for 4 goblets per level, 3 levels (single item number)	
<input type="checkbox"/> 78217558	BIOSAFE® VENUS 150 smart rack for 9 cassettes per level, 1 level (single item number)	
<input type="checkbox"/> 78224111	BIOSAFE® VENUS 180 SC, incl. roller base and connecting hose 1.5 m to APOLLO® for up to 6 racks, max 10 levels*	
<input type="checkbox"/> 78217555	BIOSAFE® VENUS 180 smart rack for vials 2ml**, 10 levels (single item number)	
<input type="checkbox"/> 78217557	BIOSAFE® VENUS 180 smart rack for goblets with drawers*** for 4 goblets per level, 4 levels (single item number)	
<input type="checkbox"/> 78217559	BIOSAFE® VENUS 180 smart rack for 9 cassettes per level, 2 levels (single item number)	

* APOLLO® and racks not included ** without cryoboxes *** without goblets

BIOSAFE® VENUS Extensive accessories

<input checked="" type="checkbox"/> Item No.		Quantity
<input type="checkbox"/> 78217560	Roller base for BIOSAFE® VENUS 150/180 (re-order reference)	
<input type="checkbox"/> 78212859	Cryobox (10x10, for 100 vials) with Cryotherm label, (single item number)	
<input type="checkbox"/> 78214364	Cryobox (9x9, for 81 vials) with Cryotherm label, (single article number)	
<input type="checkbox"/> 78212792	Transparent goblet, without lid, Ø 65 mm (single article number)	
<input type="checkbox"/> 78216990	Set of 5 transparent daisy goblets with 11 coloured inserts, lid, Ø 65 mm (set item number)	
<input type="checkbox"/> 77031488	Cassette for bags (single article number)	

▶ Our extensive security equipment can be found on pages 6 and 7.

sales@cryotherm.de

+49 (0)2741 - 95 85 0

BIOSAFE® MARATHON

For the safe Shipment of your Samples.



Datalogger for temperature recordings

All Advantages at a Glance



The safe aluminum dry shipping container for your biological-medical samples.

- ▶ For up to 500 samples, 2 ml vials
- ▶ For up to 6 bags 500 ml
- ▶ Liquid nitrogen can not go out
- ▶ Low temperatures up to -190 C°



Storage Capacities



BIOSAFE® MARATHON		25 MD
Dry-Shipper		
Total volume	[l]	25.0
Number of racks	[piece]	1
Dimension of the hybrid racks (HxWxD)	[mm]	297x133x142
2 ml vials	[up to]	500
bags size 280x120x150 mm	[up to]	8

Other dry shipper sizes and accessories on request.

Hybrid rack for bags / vials for BIOSAFE® MARATHON 25 MD
Item No. 78223756



Bags require protective cassettes. Capacity deviations are possible depending on the manufacturer.

Suitable accessories for BIOSAFE® MARATHON 25 MD

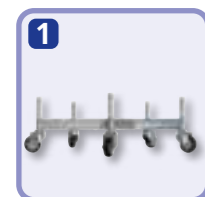

Roller base for MARATHON 25 with five swivel castors, three of them lockable
Item No. 78224116



Robust, lightweight protective packaging MARATHON 25 MD
Item No. 78217502
Height: 810 mm
Wide: 520 mm
Depth: 520 mm



Protective cap
Item No. 78217562

Extensive safety equipment from page 6



Plug with convection barrier
Item No. 78223718

3 and 4 included in the initial scope of delivery

exemplary illustration

BIOSAFE® MARATHON

Order form.



Technical Data



BIOSAFE® MARATHON		25 MD
Dry-Shipper		
Amount of nitrogen absorbed	[l]	9.5
Neck diameter	[mm]	210
Height of sample space	[mm]	305
Total height, without data logger	[mm]	705
Weight, empty, without racks	[kg]	15.0
Weight, full, without racks	[kg]	22.0
Diameter, outer	[mm]	394
Static holding time	[days]*	10

*) The daily evaporation rate and the static holding time were determined at 20 degrees Celsius, 1013 hectopascal, with the vessel standing still, lid closed and without accessories. These are nominal values that may change depending on the use and age of the container.

The BIOSAFE® MARATHON 25 is lockable and sealable*.



*) not included in the scope of delivery

Item numbers



We supply various equipment variants and a wide range of accessories for your BIOSAFE® MARATHON



BIOSAFE® MARATHON		Quantity
<input checked="" type="checkbox"/>	Item No.	
<input type="checkbox"/>	78223636 BIOSAFE® MARATHON 25 MD DRYSHIPPER	
<input type="checkbox"/>	78223756 Hybrid-Rack for BIOSAFE® MARATHON 25 MD DRYSHIPPER	
<input type="checkbox"/>	78224306 Bluetooth® pdf data logger incl. external PT100 probe	

Other container sizes on request.

BIOSAFE® MARATHON 25 Extensive accessories / spare parts

BIOSAFE® MARATHON 25 Extensive accessories / spare parts		Quantity
<input checked="" type="checkbox"/>	Item No.	
<input type="checkbox"/>	78224116 Roller base 1	
<input type="checkbox"/>	78217502 Robust, lightweight protective packaging 2	
<input type="checkbox"/>	78217562 Protective cap 3 (spare parts)	
<input type="checkbox"/>	78223718 Plug with convection barrier 4 (spare parts)	

▶ Our extensive security equipment can be found on pages 6 and 7.

sales@cryotherm.de

+49 (0)2741 - 95 85 0

ALPHA

Unpressurised Vessel Series for small Amounts of nitrogen.



All Advantages at a Glance

Safe and lightweight storage and transport vessel made in aluminium for liquid nitrogen.

SMALL, COMPACT AND STURDY.

- ▶ Available in three sizes with a capacity of approx. 6, 10 & 25 litres
- ▶ Comprehensive accessories

Technical Data

Storage Capacity ALPHA		5	10	25
Net capacity	[l]	6	10	25
Daily evaporation	[l/Day]*	0.12	0.12	0.12
Static holding time	[Days]*	50	83	208
Weight, empty	[kg]	5	6.2	10.5
Weight, full (filled with LIN)	[kg]	9.7	13.9	31.6
Total height	[mm]	468	528	700
Neck tube diameter	[mm]	50	50	50
Inner diameter	[mm]	231	231	296
Outer diameter	[mm]	300	300	396

*) The daily evaporation rate and the static holding time were determined at 20 degrees Celsius, 1013 hectopascal, with the vessel standing still, lid closed and without accessories. These are nominal values that may change depending on the use and age of the container.



Roller base for ALPHA 25 with five swivel castors, three of them lockable Item No. 78217449

Item Numbers

We supply various equipment variants and a wide range of accessories for your ALPHA.

ALPHA Lines			Quantity
<input checked="" type="checkbox"/>	Item No.		
<input type="checkbox"/>	78224172	ALPHA 5, pressureless transport/storage vessel for liquid nitrogen	
<input type="checkbox"/>	78224173	ALPHA 10, pressureless transport/storage vessel for liquid nitrogen	
<input type="checkbox"/>	78224174	ALPHA 25, pressureless transport/storage vessel for liquid nitrogen	
<input type="checkbox"/>	78217449	Roller base for ALPHA 25, with five swivel castors, three of them lockable	

Other container sizes on request.

JUNO®

Supply vessel for cryogenic liquid nitrogen



All Advantages at a Glance

Supply vessel made in stainless steel for cryogenic liquid nitrogen

SIMPLE, ROBUST, EFFICIENT.

- ▶ Efficient exhaust gas cooling system, optimized super-insulation, compact dimensions, Pressure gauge
- ▶ Integrated safety device on vessel neck
- ▶ Combined positive pressure-relief and seal-off device

Technical Data

Storage Capacity JUNO®		30
Geometrical capacity	[l]	30
Operating overpressure	[bar]	1.3
Empty weight	[kg]	18
Full weight	[kg]	41
Decanting head connection		KF 50
Total height	[mm]	660
Immersion depth	[mm]	533
Outside diameter	[mm]	369
Total width	[mm]	407
Static evaporation rate	[l/day]	0.75



Item Numbers

We supply a wide range of accessories for your Juno® 30.

JUNO® 30			Quantity
<input checked="" type="checkbox"/>	Item No.		
<input type="checkbox"/>	78220205	JUNO® 30, 1.3 bar with transport plug	
<input type="checkbox"/>	78220349	Roller base	
<input type="checkbox"/>	78220412	Decanting head with waste gas and overflow valve	
<input type="checkbox"/>	79229957	Decanting hose (1.5 m)	
<input type="checkbox"/>	79404217	Phase separator	

Special options on request

All Advantages at a Glance



Best in it's class!

Evaporation rate for e.g. APOLLO® 200: Only 0.6% per day!

A ball valve for comfortable view: "Open or close"

Ideal operating height and user-friendly fittings (ball valves)

Safety measures at eye level

High stability for secure and smooth transport

Time savings through increased uptime for your application

Robust protective frame for safe transport

Higher service life with the following advantages: Savings in transport and handling costs

High quality design made of corrosion-resistant stainless steel

Low maintenance

Large, stable and smooth-running wheels (Ø 125-160 mm) without sharp edges

Great mobility through compact design

Long-term vacuum protection through high-quality adsorption and getter materials



Including Accessories



Gloves



Item No.: 07794111

exemplary illustration

Safety glasses with side protection



Item No.: 07794189

Transfer hose 1,5 m



Item No.: 79229957

Phase separator G 3/8" complete



Item No.: 79404217

(everything included)

Applications

APOLLO®



compatible

- ▶ Analysers
- ▶ Cryogenic mills
- ▶ Cryogenic saunas
- ▶ Freezers
- ▶ Biobanks
- ▶ BIOSAFE®

...

Essential Construction Elements and Equipment

- | | |
|---------------------------------------|---|
| 1 Extraction valve | 12 Vacuum sealing and safety valve |
| 2 Exhaust and overflow valve | 13 Superinsulation |
| 3 Pressure build-up valve | 14 Absorbents (long-term vacuum protection) and special getters |
| 4 Pressure gauges | 15 Exhaust and overflow line |
| 5 Safety valve | 16 Sampling line |
| 6 Analog level indicator (opt.) | 17 Pressure build-up line |
| 7 Filling hose | 18 Chassis and protective frame |
| 8 Phase separator | 19 Indoor and outdoor vessel |
| 9 Castors | 20 Gaseous nitrogen |
| 10 Pressure regulator (opt.) | 21 Liquid nitrogen |
| 11 Pressure build-up regulator (opt.) | |

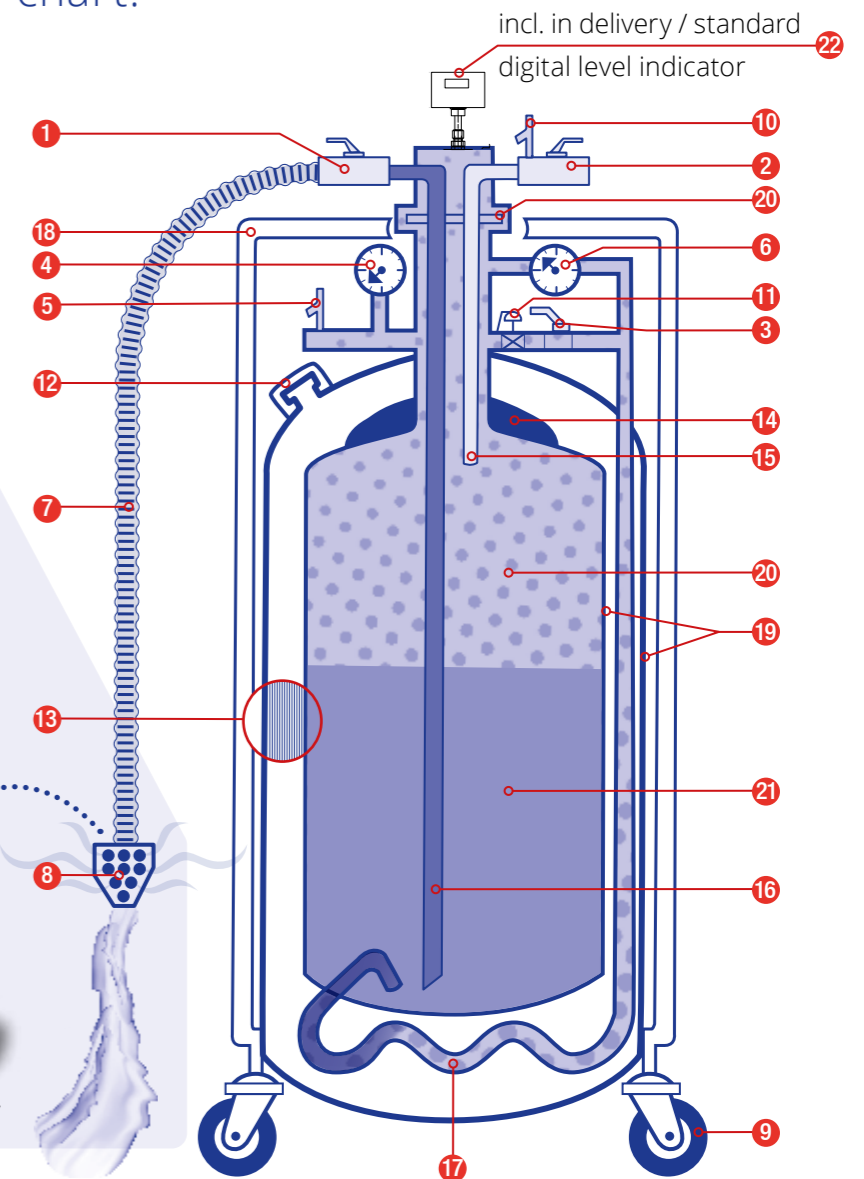

incl. in delivery / standard
digital level indicator 22

Standard equipment

- With digital level indicator (APOLLO® 100 - 350) Integrated
- safety device on the vessel neck
- Vacuum seal and safety device
- Smooth-running castors and transport protection frame
- Level and pressure gauge
- EK lift with exhaust and overflow valve
- Integrated pressure build-up
- Filling hose (1.5 m) with phase separator
- Cold protection gloves **1** and safety glasses **2** with side protection



exemplary illustration

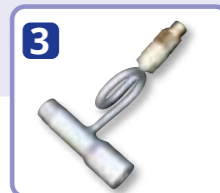

for a fixed connection of an APOLLO® urgently required!

Technical Data



Vessel made Stainless steel		APOLLO® 50 1.3 bar	APOLLO® 100 1.3 bar	APOLLO® 150 1.3 bar	APOLLO® 200 2.0 bar	APOLLO® 350 2.0 bar
Approval mark		CE	CE	CE	CE0035	CE0035
Geometrical capacity	[l]	49.4	98.8	149.15	199.5	348.7
Operating overpressure max.	[bar]	1.3	1.3	1.3	2.0	2.0
Weight, empty	[kg]	44	62	79	100	160
Weight, full LIN	[kg]	85	145	204	266	450
Stat. evaporation rate LIN	[%/Day]	2	1.2	1	0.6	0.5
Total height incl. digital level ind.	A [mm]	905	1,240	1,580	1,350	1,785
Total height until siphon	B [mm]	765	1,100	1,440	1,170	1,650
Diameter, outer	C [mm]	500	500	500	700	700
Total width	D [mm]	650	650	650	800	800
Depth of immersion	E [mm]	585	920	1,220	910	1,350
Castor diameter	F [mm]	125	125	125	160	160
Neck diameter	G [mm]	50	50	50	50	50
Siphon connection		KF 50	KF 50	KF 50	KF 50	KF 50

Upon request the APOLLO® series is also available for other types of gas.

! Our APOLLO®-Series is available with a capacity of 50 to 350 litres

For dimensions see table.

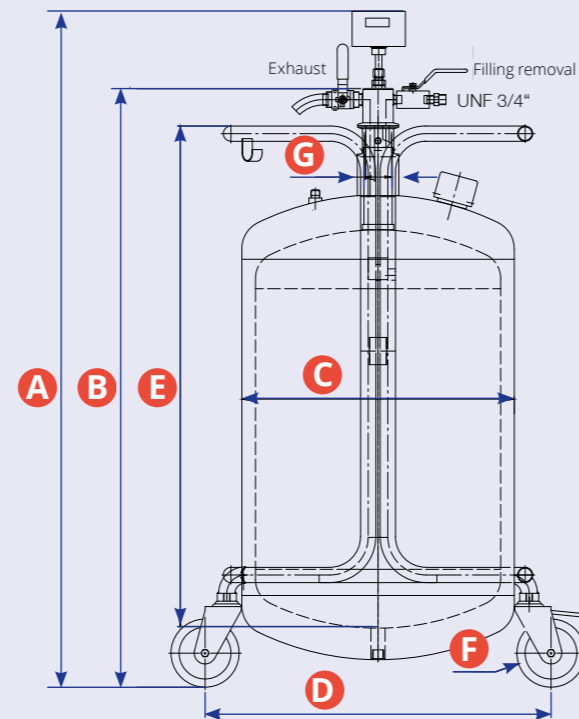

Options

- Pressure build-up regulator (Item No. 78202710)
- Pressure reduction regulator (Item No. 78203080)
- Double extraction liquid side (Item No. 79415416)
- Double extraction gas side (Item No. 78203081)
- Triple extraction liquid side (Item No. 79418082)
- Triple extraction gas side (Item No. 78203082)
- Safety spacer **3** (Item No. 78206124)
- Level indicator, capacitive, battery
- Forklift pockets **6**
- Set of castors, antimagnetic
- Reversion APOLLO® 50/100/150 to 4 bar

Further options available upon request.

▶ Our APOLLO® series complies with the European Pressure Equipment Directive 2014/68 / EU

▶ Reversion APOLLO® 50/100/150 to 4 bar, incl. pressure reduction regulator Item No. 78224071 (exemplary illustration)



The **digital display** – the capacitive level indicator for your APOLLO®

- ▶ Display and probe in one device
- ▶ Easy to use
- ▶ High precision



Practical **forklift pockets** facilitate the handling of your APOLLO®



Standard with digital display APOLLO® 100-350



Item Numbers



APOLLO® liquid nitrogen vessel	also available as 4 bar version				
	50*	100*	150*	200	350
with digital level indicator 5	78202700	78223344	78223345	78223346	78223347
Options for APOLLO® line					
Forklift pockets 6	78203083	78203083	78203083	78203975	78203900
Set of castors, antimagnetic	78200474	78200474	78200474	78203992	78203992

*1) Reversion APOLLO® 50/100/150 to 4 bar, incl. pressure reduction regulator. Item No. 78224071

**1) With analog level indicator. Item No. 78202700



Notizen 

60
YEARS
1964 - 2024

**Excellence
in Engineering**

Cryotherm GmbH & Co. KG

Euteneuen 4
D-57548 Kirchen/Sieg, Germany
Telephone: ++49 27 41 / 95 85-0
Fax: ++49 27 41 / 69 00
E-mail: sales@cryotherm.de



Cryotherm Inc.

5126 South Royal Atlanta Drive
Tucker, GA 30084, USA
Telephone: +1 770-274-2410
Fax: +1 770-934-3384
E-mail: info@cryotherminc.com



Your local contact person:



Illustrations may differ. Subject to technical changes.
Version 2023